

PARTS LIST		
QNTY	LABEL	NAME
2	TH-B2VF	TH - BOTTOM 2 VERTICAL FRAME
1	TH-B1HF	TH - BOTTOM 1 HORIZONTAL FRAME
1	TH-T1HF	TH - TOP 1 HORIZONTAL FRAME

FABRIC GRAPHIC APPLICATION

1st Step)

APPLY TOP CORNER WITH VELCRO AND ZIPPER TO TOP CORNER OF FRAME



2nd Step)

USING EVEN PRESSURE, CONTINUE CONNECTING TOP OF GRAPHIC WITH VELCRO ALONG TOP OF FRAME CONTAINING VELCRO



3rd Step)

AFTER GRAPHIC VELCRO IS APPLIED AROUND ENTIRE TOP OF FRAME, CONNECT ZIPPER AND ZIPPER GRAPHIC DOWN CORNER



4th Step)

PULL BOTTOM OF GRAPHIC DOWN ON EACH CORNER TO EVEN OUT SURFACE, AND REDUCE ANY WRINKLES

1st Step)

START WITH CONNECTING BOTTOM HORIZONTAL FRAME WITH BOTTOM VERTICAL FRAMES

2nd Step)

ATTACH THE TOP HORIZONTAL FRAME TO SIDES OF PREVIOUSLY CONSTRUCTED BOTTOM VERTICAL FRAMES

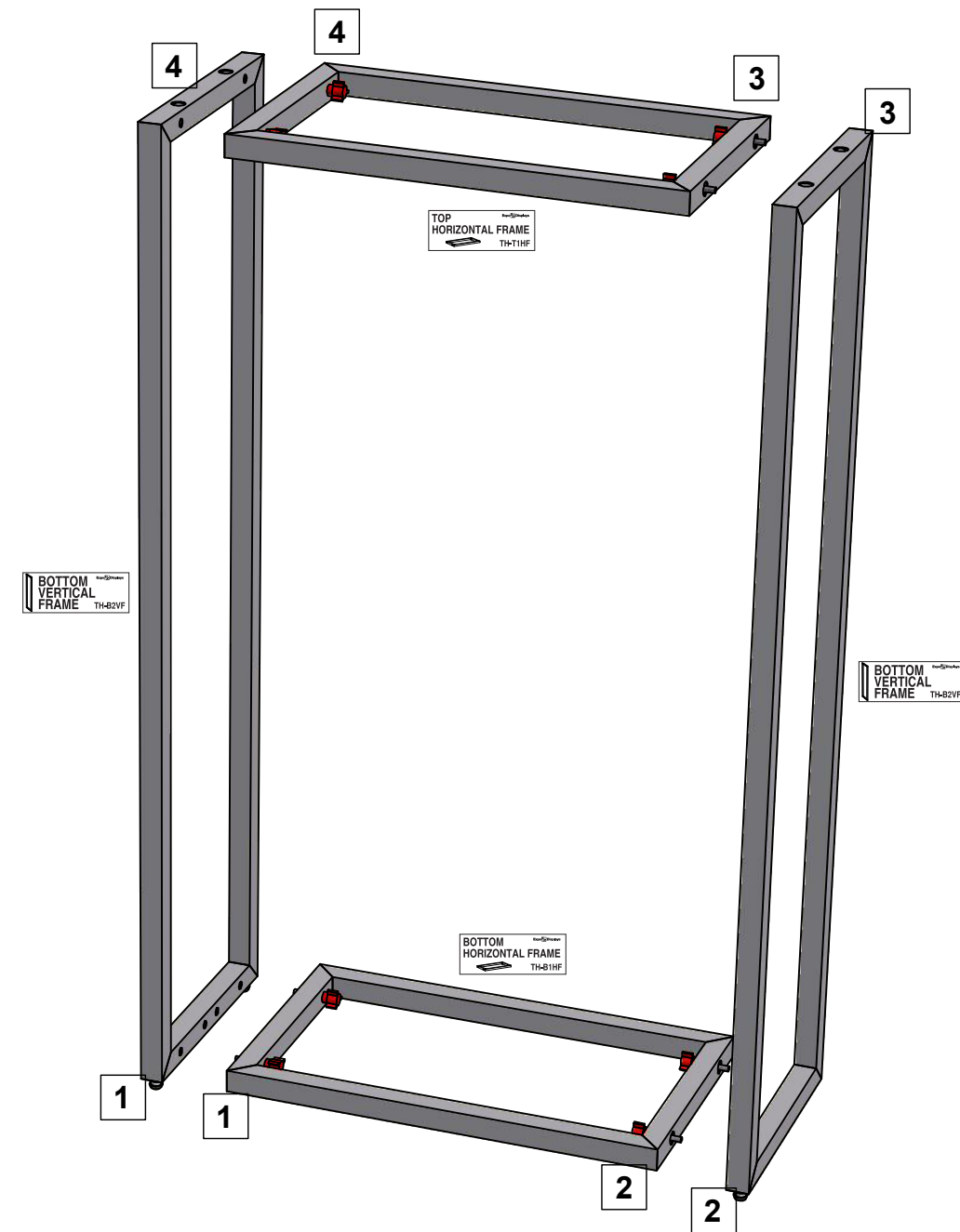

*MATCH NUMBERS TO CONSTRUCT

THIS PART USED TO MAKE
TH-F12
1x2 STANDARD THREADS

ASSEMBLY INSTRUCTIONS
EXPO DISPLAYS - THREADS
TH-F12 ASSEMBLY