

ASSEMBLY INSTRUCTIONS:



3401 Mary Taylor Road
Birmingham, Alabama 35235
(205) 439-8200

KIT #02

10 x 10 Silhouette®

■ Electrical Plan

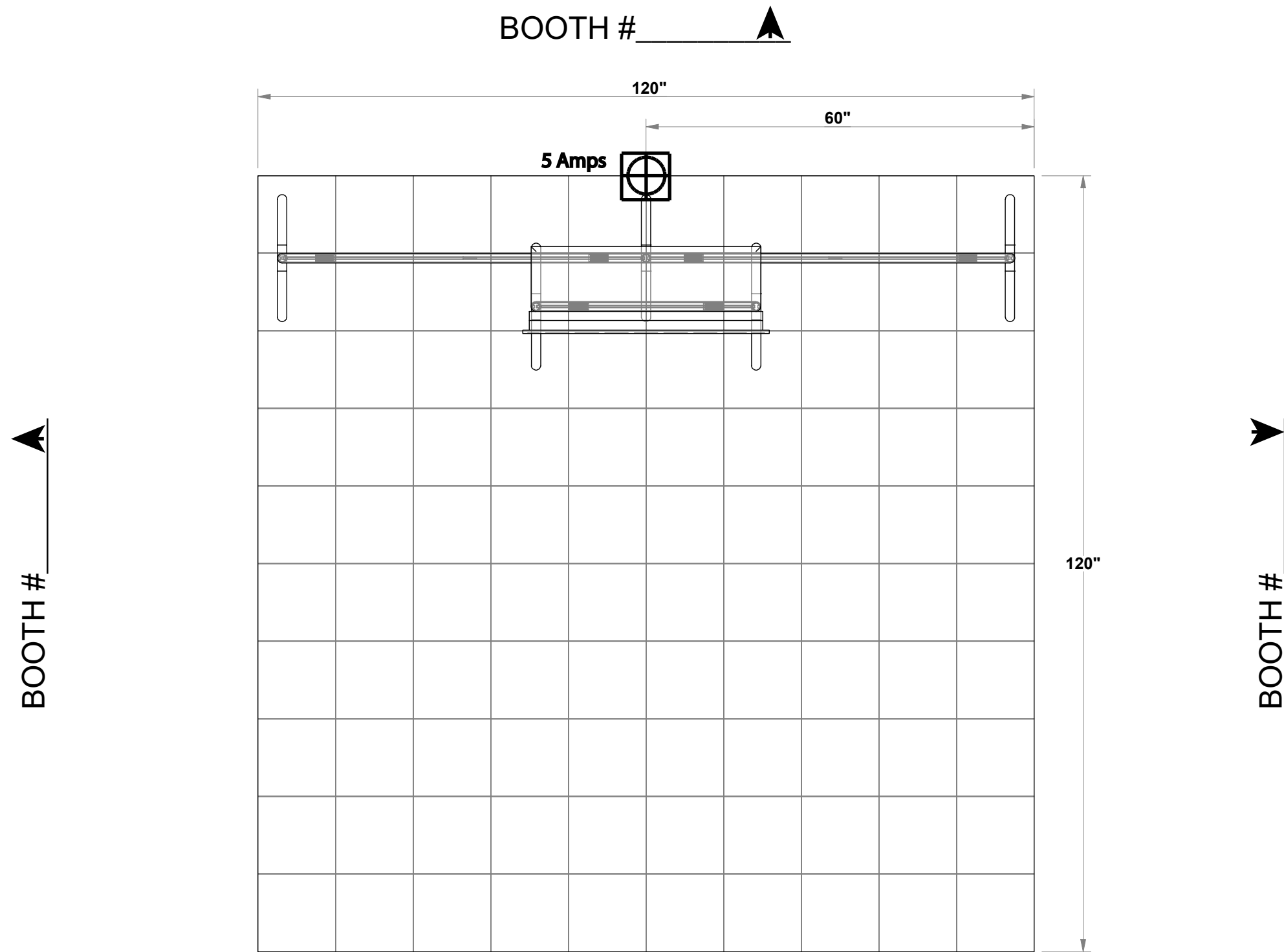

TOP VIEW

	MAIN ELECTRICAL DROP
	ADDITIONAL ELECTRICAL OUTLET

BOOTH # _____ ▼

ASSEMBLY INSTRUCTIONS:

* NO TOOLS REQUIRED TO ASSEMBLE

* ASSEMBLE EACH BOXED FRAME INDIVIDUALLY THEN JOIN AS SHOWN IN THE FOLLOWING PAGES:

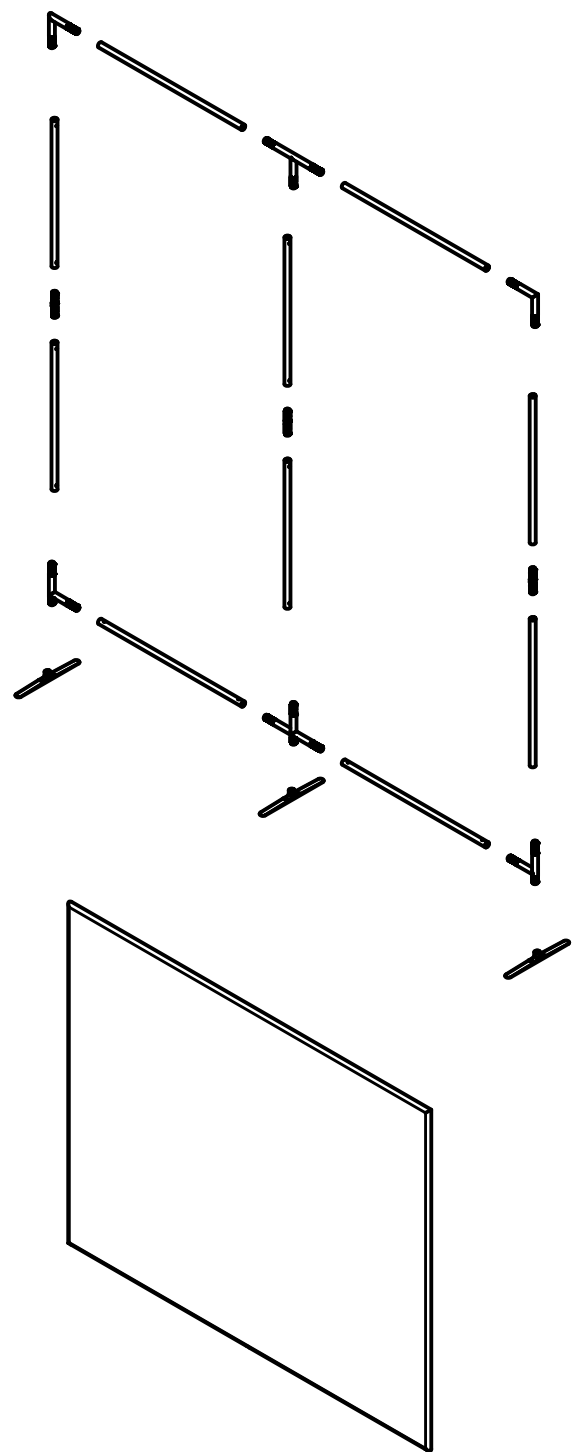

8 X 10 SILHOUETTE

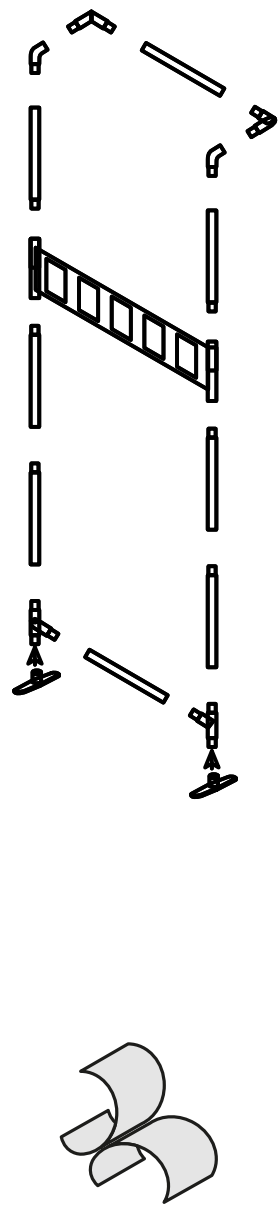

8 X 3_TV SILHOUETTE

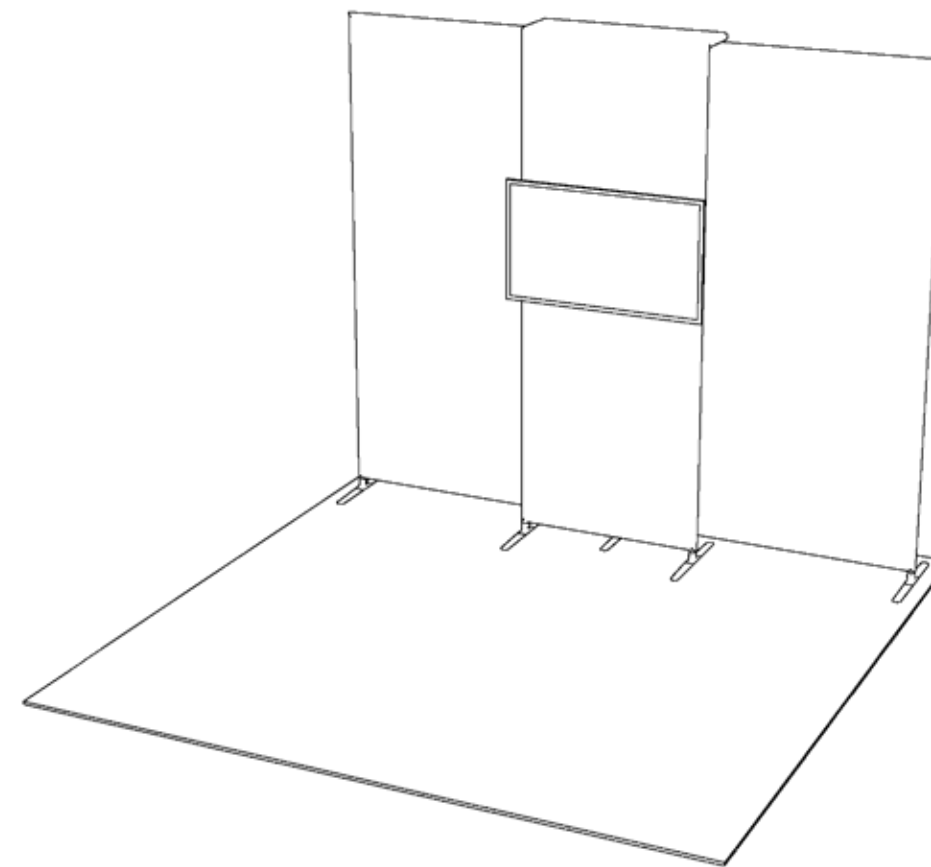

10 x 10 Silhouette®



3401 Mary Taylor Road
Birmingham, Alabama 35235
(205) 439-8200

KIT #02



SILHOUETTE - 8 X 10 FRAME

ASSEMBLY INSTRUCTIONS

FEATURING

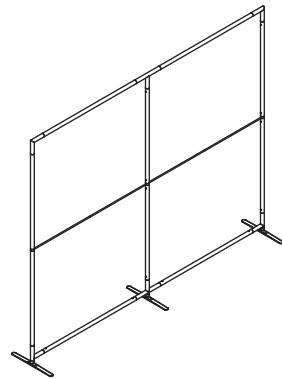
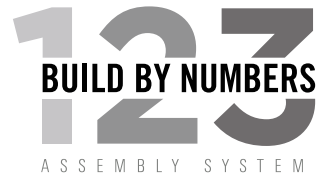

PARTS LIST:		
#	LABEL	NAME
2	SLP-LJT L-JOINER - TOP	L-JOINER (TOP)
6	SLP-VB VERTICAL BAR	VERTICAL BAR
4	SLP-HB810 HORIZONTAL BAR FOR 8x10	HORIZ BAR - (8 X 10)
2	SLP-B810 BRACE FOR 8x10	BRACE - (8 X 10)
2	SLP-LJB L-JOINER - BOTTOM	L-JOINER (BOTTOM)
3	SLP-IJ I-JOINER	I-JOINER
3	FOOT SILHOUETTE FOOT	FOOT
1	SLP-TJT T-JOINER - TOP	T-JOINER (TOP)
1	SLP-TJB T-JOINER - BOTTOM	T-JOINER (BOTTOM)

Silhouette uses ExpoDisplays' Build By Numbers Assembly System to make assembly simple.

Build the frame by joining the parts together with the matching number stickers - 1 to 1, 2 to 2, and so on. Join vertical bars with I-Joiners (Fig. A) Once all numbered pieces are joined, insert feet to bottom of frame (Fig. B)

Once the frame is assembled, stand it up on its feet. Next, slide the fabric graphic on over the frame, and zip it closed at the bottom (Fig. C).

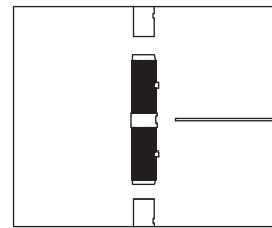
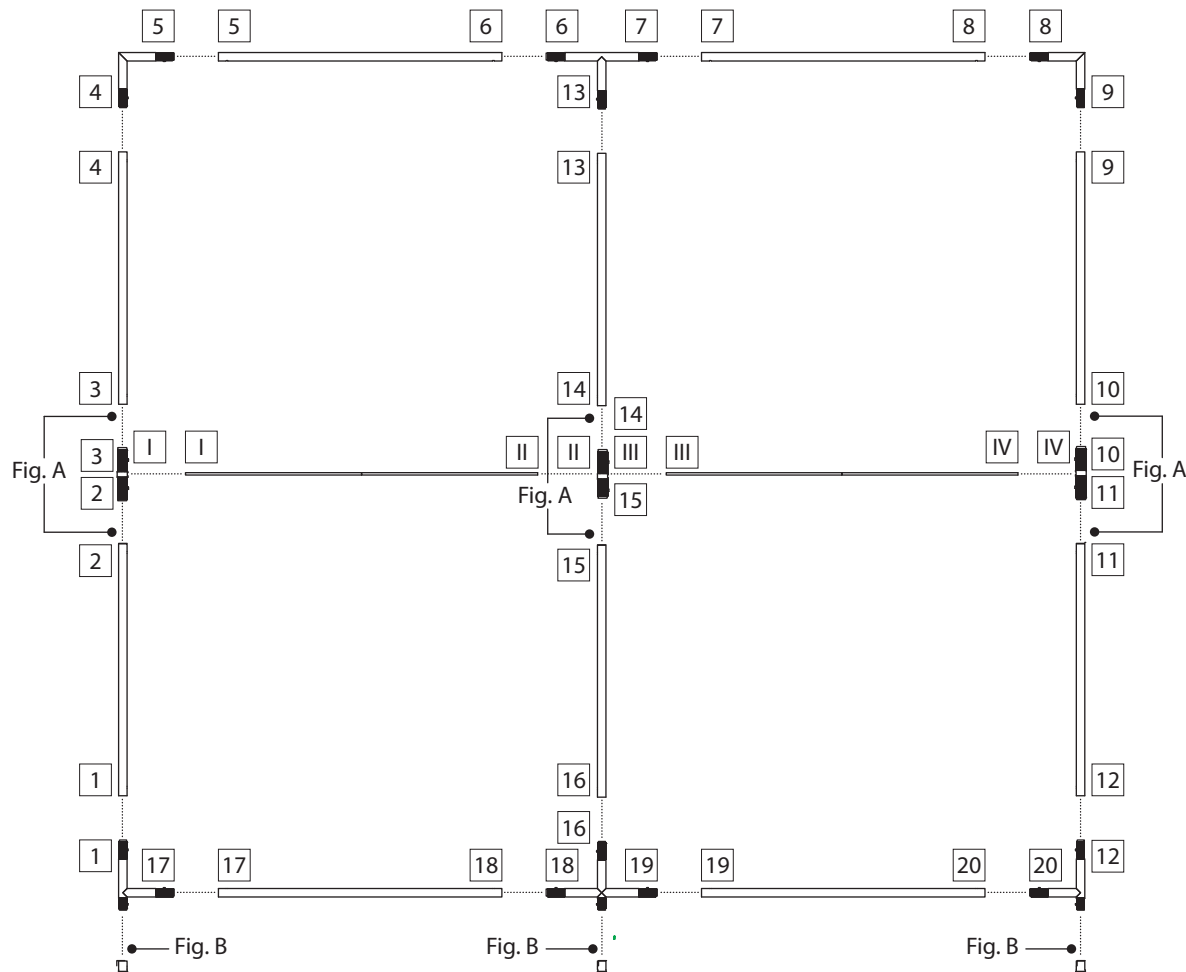

Fig. A

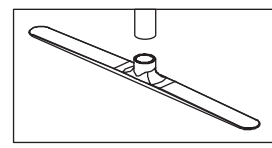

Fig. B

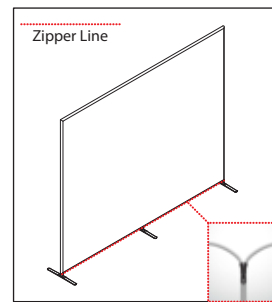

Fig. C

updated 8-9-17



SILHOUETTE - 8 x 3 FRAME (TV SETUP)

ASSEMBLY INSTRUCTIONS

FEATURING

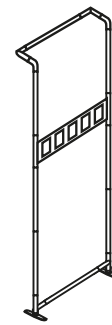
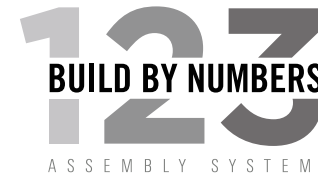

PARTS LIST:		
#	LABEL	NAME
2	SLP-LJT L-JOINER - TOP	L-JOINER (TOP)
4	SLP-VB VERTICAL BAR	VERTICAL BAR
2	SLP-HB83 HORIZONTAL BAR FOR 3x8	HORIZ BAR - (8 X 3)
1	SLP-B83 BRACE FOR 8x3	BRACE - (8 X 3)
2	SLP-LJB L-JOINER - BOTTOM	L-JOINER (BOTTOM)
2	SLP-IJ I-JOINER	I-JOINER
2	FOOT SILHOUETTE FOOT	FOOT

Silhouette uses ExpoDisplays' Build By Numbers Assembly System to make assembly simple.

Build the frame by joining the parts together with the matching number stickers - 1 to 1, 2 to 2, and so on. Join vertical bars with I-Joiners (Fig. A) Once all numbered pieces are joined, insert feet to bottom of frame (Fig. B)

Once the frame is assembled, stand it up on its feet. Next, slide the fabric graphic on over the frame, and zip it closed at the bottom (Fig. C).

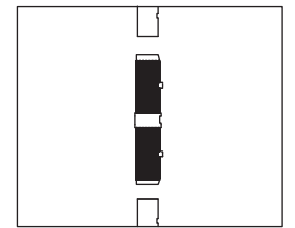
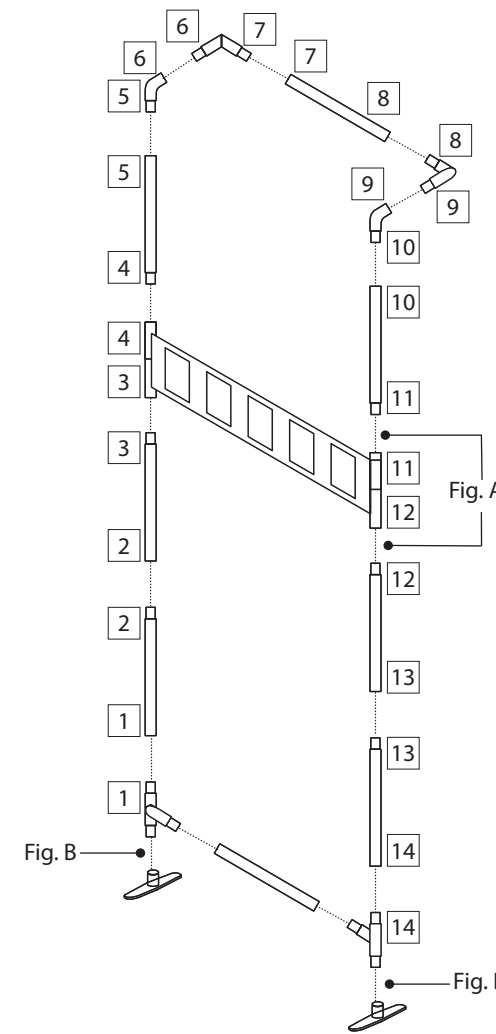

Fig. A

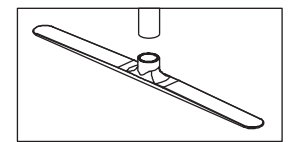

Fig. B

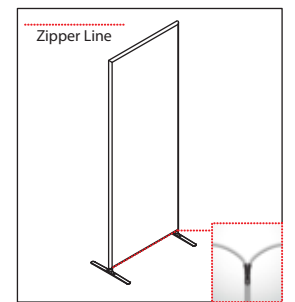

Fig. C

updated 8-20-20

ASSEMBLY INSTRUCTIONS:



3401 Mary Taylor Road
Birmingham, Alabama 35235
(205) 439-8200

KIT #02

10 x 10 Silhouette®

1

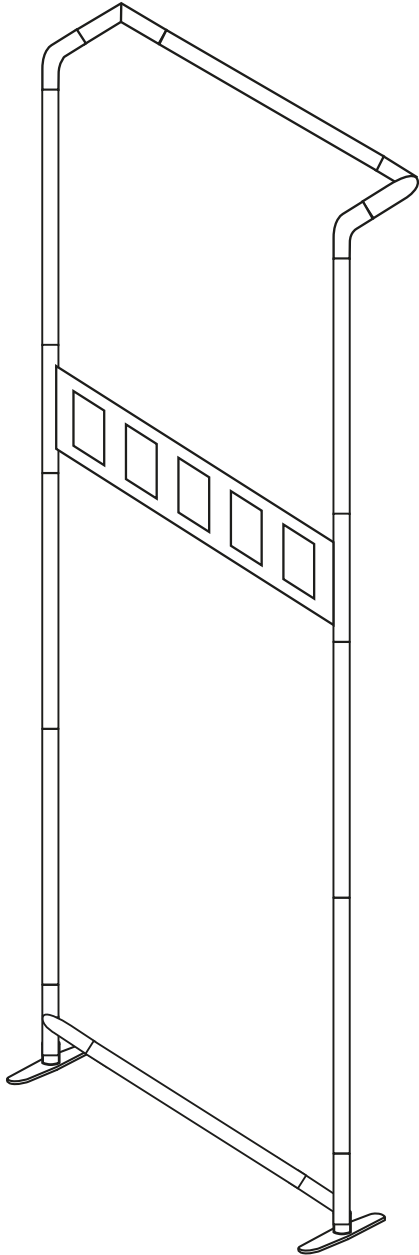

SET UP INSTRUCTIONS
FRAME

2

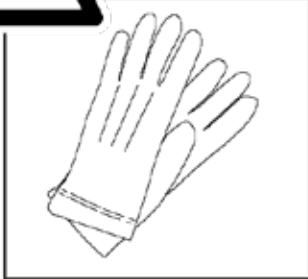
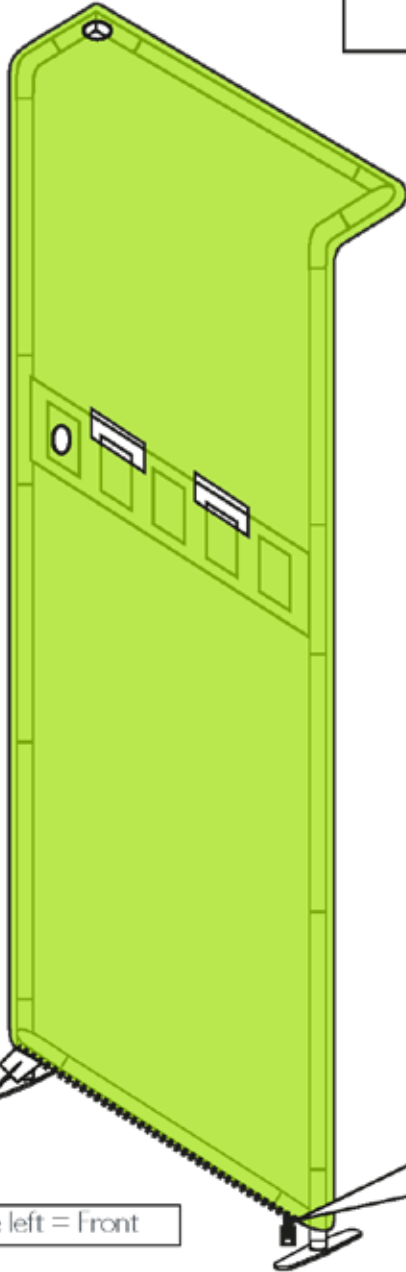
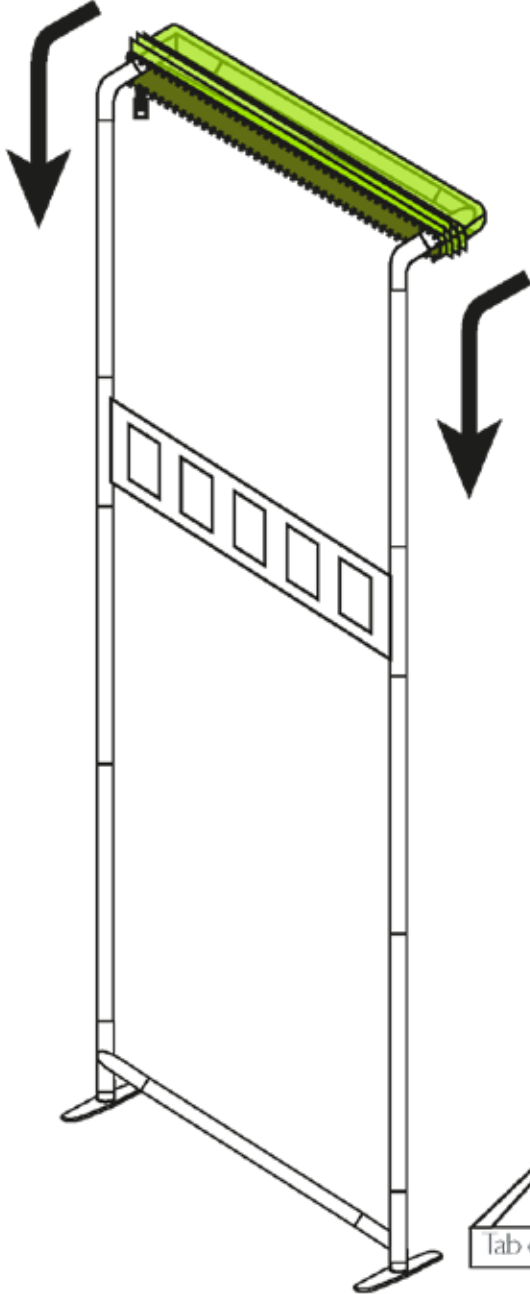

Tips: Use gloves and work on a clean site.

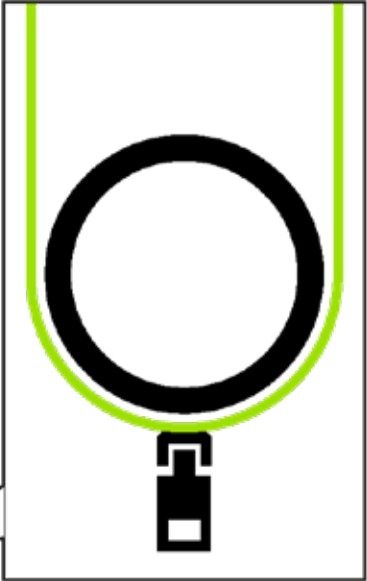
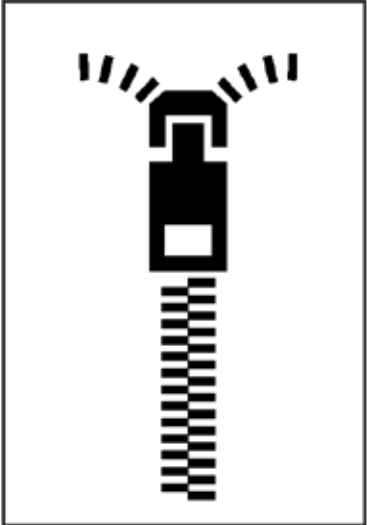

lab on the left = Front

ASSEMBLY INSTRUCTIONS:



3401 Mary Taylor Road
Birmingham, Alabama 35235
(205) 439-8200

KIT #02

10 x 10 Silhouette®



SET UP INSTRUCTIONS CONNECTING FRAMES

3

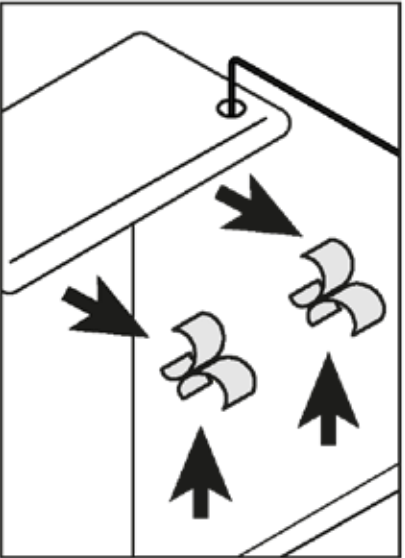

4

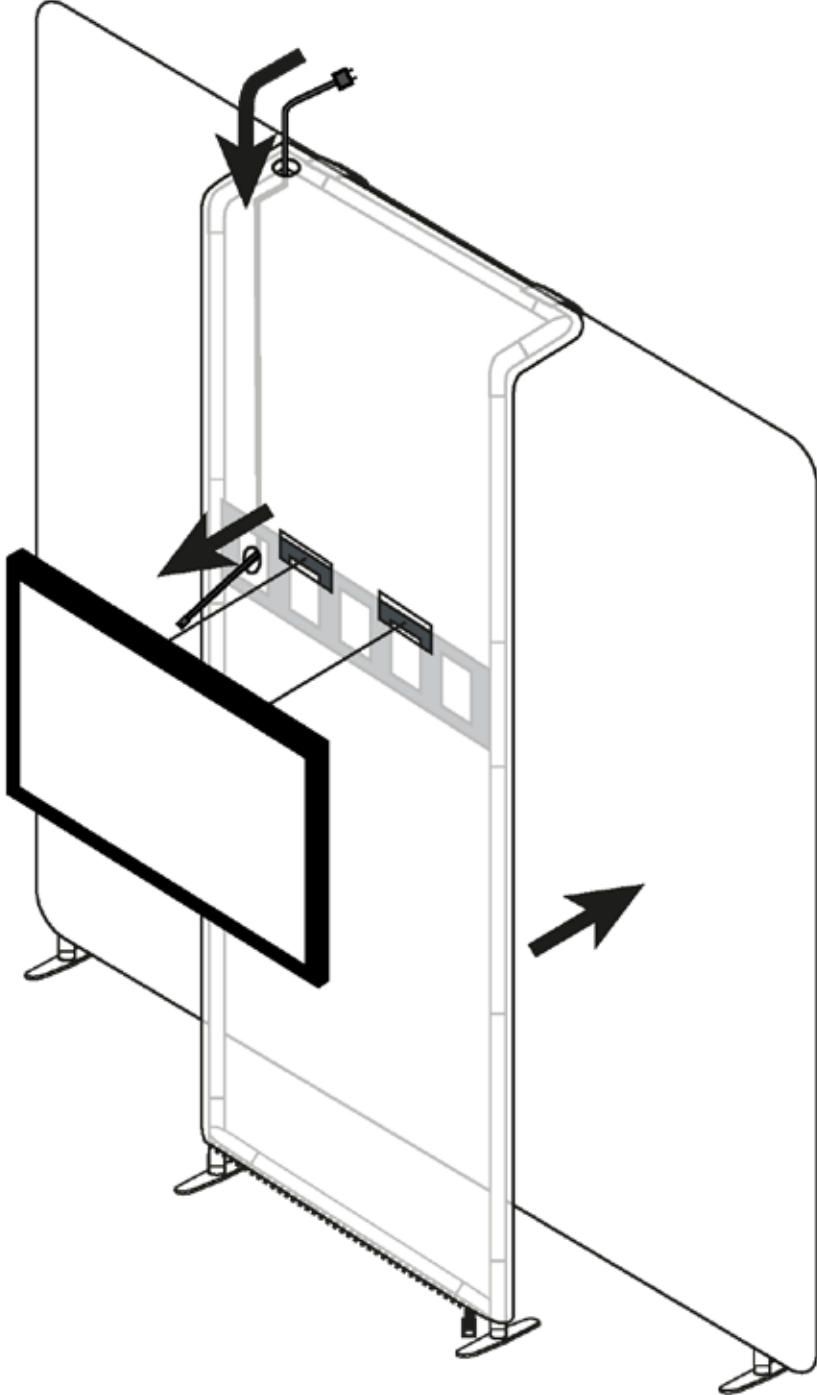
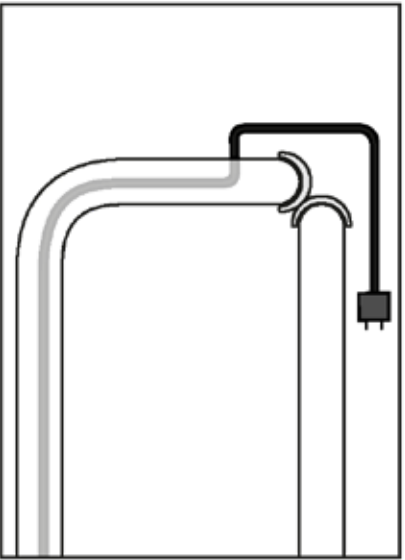

5

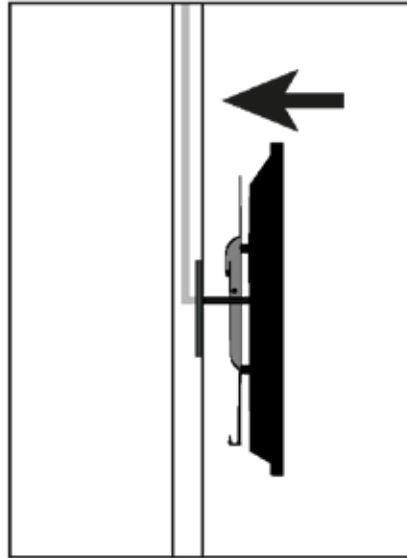

6

